

# IRF840PbF

## HEXFET® Power MOSFET

- Dynamic dv/dt Rating
- Repetitive Avalanche Rated
- Fast Switching
- Ease of Paralleling
- Simple Drive Requirements
- Lead-Free

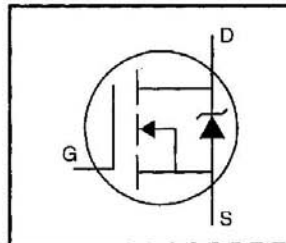

$$V_{DSS} = 500V$$

$$R_{DS(on)} = 0.85\Omega$$

$$I_D = 8.0A$$

### Description

Third Generation HEXFETs from International Rectifier provide the designer with the best combination of fast switching, ruggedized device design, low on-resistance and cost-effectiveness.

The TO-220 package is universally preferred for all commercial-industrial applications at power dissipation levels to approximately 50 watts. The low thermal resistance and low package cost of the TO-220 contribute to its wide acceptance throughout the industry.

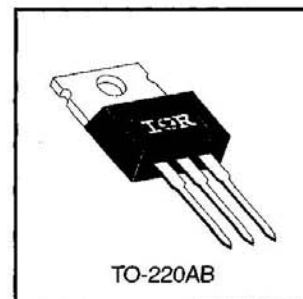

### Absolute Maximum Ratings

	Parameter	Max.	Units
$I_D @ T_C = 25^\circ C$	Continuous Drain Current, $V_{GS} @ 10 V$	8.0	A
$I_D @ T_C = 100^\circ C$	Continuous Drain Current, $V_{GS} @ 10 V$	5.1	
$I_{DM}$	Pulsed Drain Current ①	32	
$P_D @ T_C = 25^\circ C$	Power Dissipation	125	W
	Linear Derating Factor	1.0	W/°C
$V_{GS}$	Gate-to-Source Voltage	$\pm 20$	V
$E_{AS}$	Single Pulse Avalanche Energy ②	510	mJ
$I_{AR}$	Avalanche Current ①	8.0	A
$E_{AR}$	Repetitive Avalanche Energy ①	13	mJ
dv/dt	Peak Diode Recovery dv/dt ③	3.5	V/ns
$T_J$ $T_{STG}$	Operating Junction and Storage Temperature Range	-55 to +150	°C
	Soldering Temperature, for 10 seconds	300 (1.6mm from case)	
	Mounting Torque, 6-32 or M3 screw	10 lbf·in (1.1 N·m)	

### Thermal Resistance

	Parameter	Min.	Typ.	Max.	Units
$R_{\theta JC}$	Junction-to-Case	—	—	1.0	°C/W
$R_{\theta CS}$	Case-to-Sink, Flat, Greased Surface	—	0.50	—	
$R_{\theta JA}$	Junction-to-Ambient	—	—	62	

### Electrical Characteristics @ $T_J = 25^\circ\text{C}$ (unless otherwise specified)

	Parameter	Min.	Typ.	Max.	Units	Test Conditions
$V_{(BR)DSS}$	Drain-to-Source Breakdown Voltage	500	—	—	V	$V_{GS}=0V, I_D=250\mu A$
$\Delta V_{(BR)DSS}/\Delta T_J$	Breakdown Voltage Temp. Coefficient	—	0.78	—	V/°C	Reference to $25^\circ\text{C}$ , $I_D=1\text{mA}$
$R_{DS(on)}$	Static Drain-to-Source On-Resistance	—	—	0.85	$\Omega$	$V_{GS}=10V, I_D=4.8A$ ③
$V_{GS(th)}$	Gate Threshold Voltage	2.0	—	4.0	V	$V_{DS}=V_{GS}, I_D=250\mu A$
$g_{fs}$	Forward Transconductance	4.9	—	—	S	$V_{DS}=50V, I_D=4.8A$ ④
$I_{DSS}$	Drain-to-Source Leakage Current	—	—	25	$\mu A$	$V_{DS}=500V, V_{GS}=0V$
		—	—	250		$V_{DS}=400V, V_{GS}=0V, T_J=125^\circ\text{C}$
$I_{GSS}$	Gate-to-Source Forward Leakage	—	—	100	nA	$V_{GS}=20V$
	Gate-to-Source Reverse Leakage	—	—	-100		$V_{GS}=-20V$
$Q_g$	Total Gate Charge	—	—	63	nC	$I_D=8.0A$
$Q_{gs}$	Gate-to-Source Charge	—	—	9.3		$V_{DS}=400V$
$Q_{gd}$	Gate-to-Drain ("Miller") Charge	—	—	32		$V_{GS}=10V$ See Fig. 6 and 13 ④
$t_{d(on)}$	Turn-On Delay Time	—	14	—	ns	$V_{DD}=250V$
$t_r$	Rise Time	—	23	—		$I_D=8.0A$
$t_{d(off)}$	Turn-Off Delay Time	—	49	—		$R_G=9.1\Omega$
$t_f$	Fall Time	—	20	—		$R_D=31\Omega$ See Figure 10 ④
$L_D$	Internal Drain Inductance	—	4.5	—	nH	Between lead, 6 mm (0.25in.) from package and center of die contact 
$L_S$	Internal Source Inductance	—	7.5	—		
$C_{iss}$	Input Capacitance	—	1300	—	pF	$V_{GS}=0V$
$C_{oss}$	Output Capacitance	—	310	—		$V_{DS}=25V$
$C_{rss}$	Reverse Transfer Capacitance	—	120	—		$f=1.0\text{MHz}$ See Figure 5

### Source-Drain Ratings and Characteristics

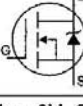
	Parameter	Min.	Typ.	Max.	Units	Test Conditions
$I_S$	Continuous Source Current (Body Diode)	—	—	8.0	A	MOSFET symbol showing the integral reverse p-n junction diode. 
$I_{SM}$	Pulsed Source Current (Body Diode) ①	—	—	32		
$V_{SD}$	Diode Forward Voltage	—	—	2.0	V	$T_J=25^\circ\text{C}, I_S=8.0A, V_{GS}=0V$ ③
$t_{rr}$	Reverse Recovery Time	—	460	970	ns	$T_J=25^\circ\text{C}, I_F=8.0A$
$Q_{rr}$	Reverse Recovery Charge	—	4.2	8.9	$\mu C$	$di/dt=100A/\mu s$ ④
$t_{on}$	Forward Turn-On Time	Intrinsic turn-on time is negligible (turn-on is dominated by $L_S+L_D$ )				

#### Notes:

- ① Repetitive rating; pulse width limited by max. junction temperature (See Figure 11)
- ②  $V_{DD}=50V$ , starting  $T_J=25^\circ\text{C}$ ,  $L=14\text{mH}$ ,  $R_G=25\Omega$ ,  $I_{AS}=8.0A$  (See Figure 12)
- ③  $I_{SD}\leq 8.0A$ ,  $di/dt\leq 100A/\mu s$ ,  $V_{DD}\leq V_{(BR)DSS}$ ,  $T_J\leq 150^\circ\text{C}$
- ④ Pulse width  $\leq 300\mu s$ ; duty cycle  $\leq 2\%$ .

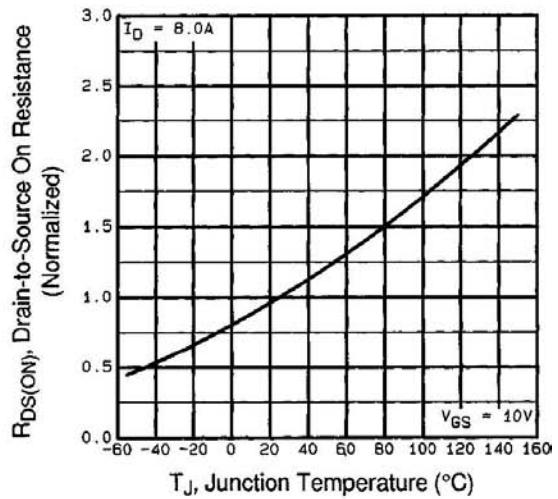
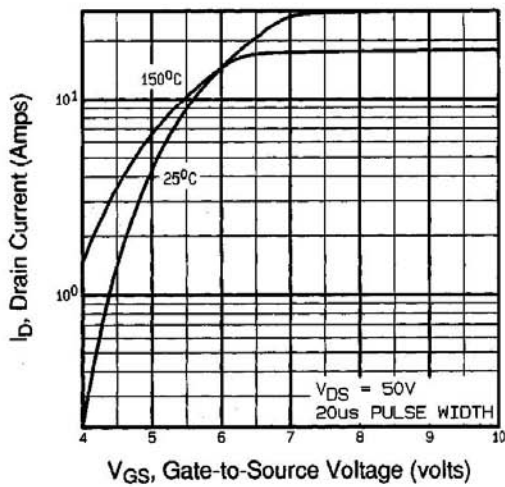
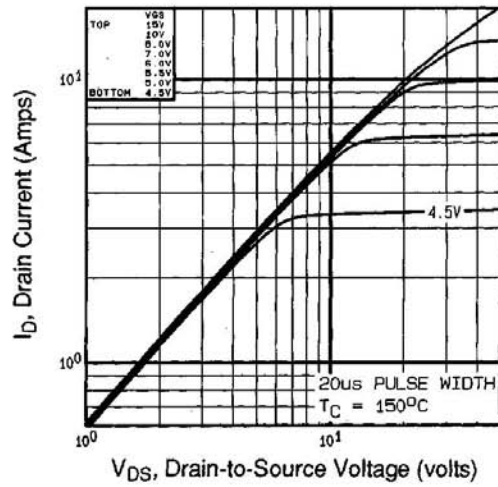
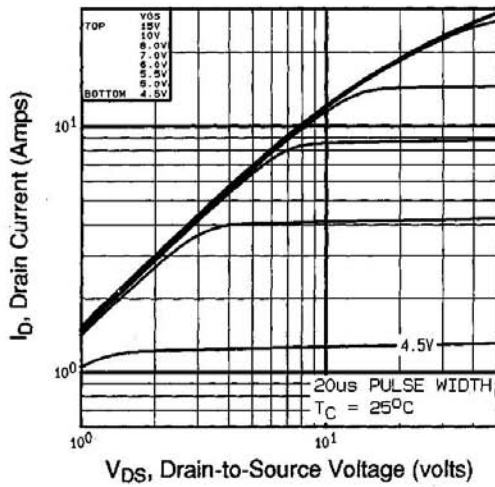

# IRF840PbF

International  
**IR** Rectifier

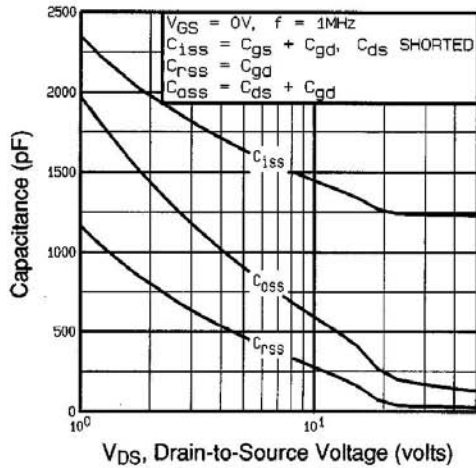

**Fig 5.** Typical Capacitance Vs. Drain-to-Source Voltage

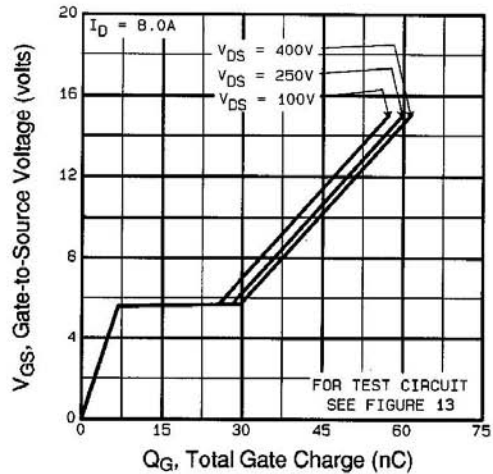

**Fig 6.** Typical Gate Charge Vs. Gate-to-Source Voltage

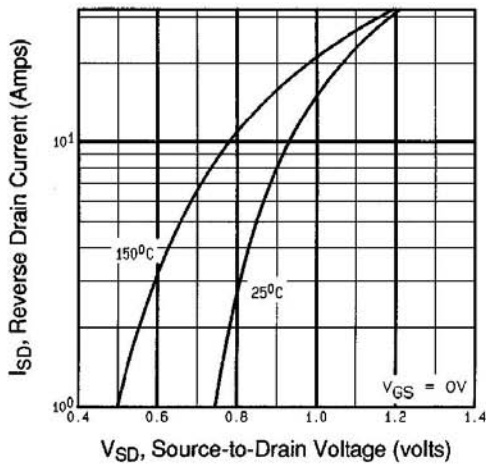

**Fig 7.** Typical Source-Drain Diode Forward Voltage

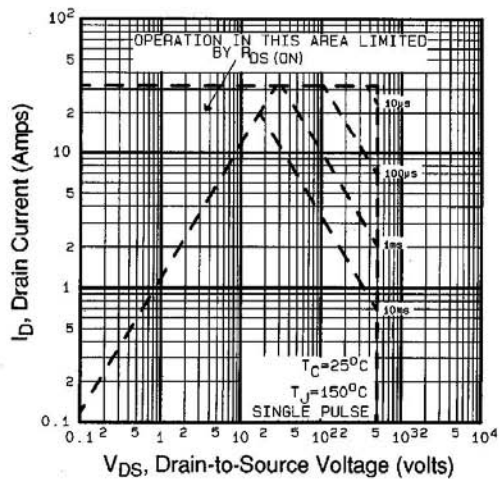

**Fig 8.** Maximum Safe Operating Area



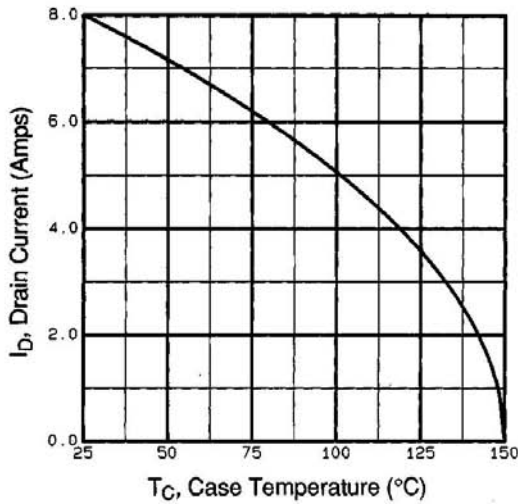

Fig 9. Maximum Drain Current Vs. Case Temperature

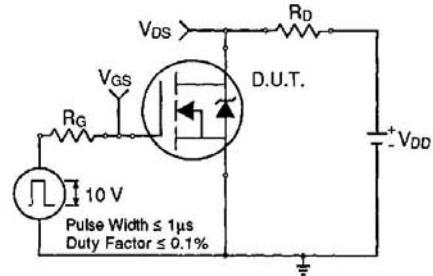

Fig 10a. Switching Time Test Circuit

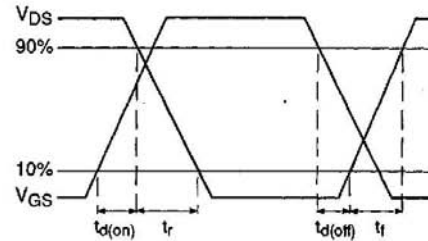

Fig 10b. Switching Time Waveforms

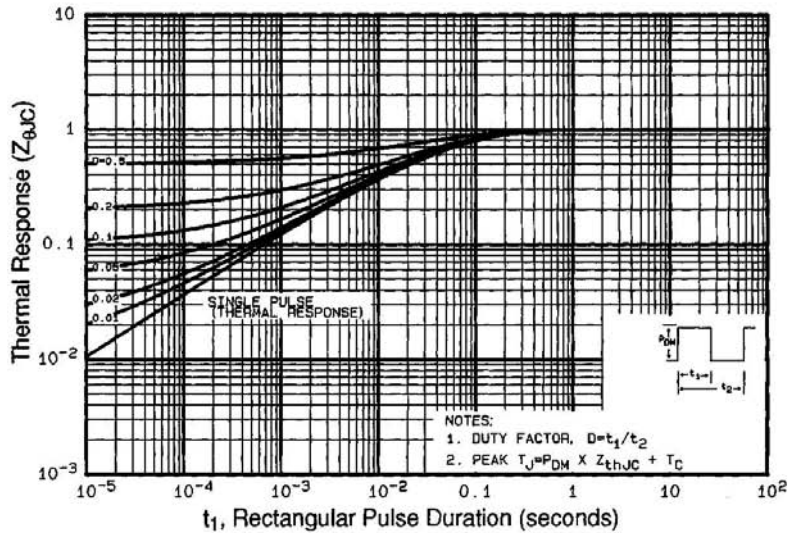
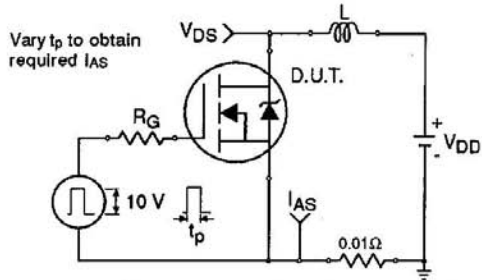

Fig 11. Maximum Effective Transient Thermal Impedance, Junction-to-Case

# IRF840PbF

International  
**IR** Rectifier



**Fig 12a.** Unclamped Inductive Test Circuit

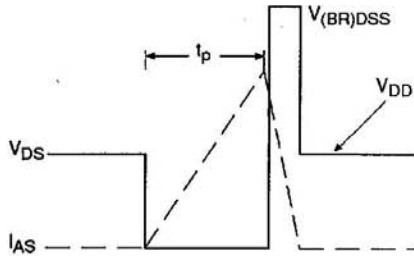

**Fig 12b.** Unclamped Inductive Waveforms

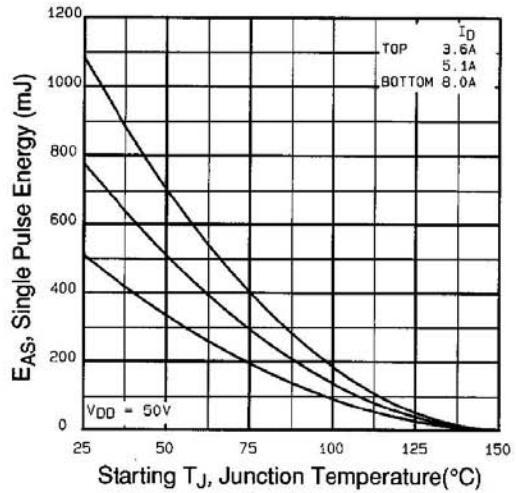

**Fig 12c.** Maximum Avalanche Energy Vs. Drain Current

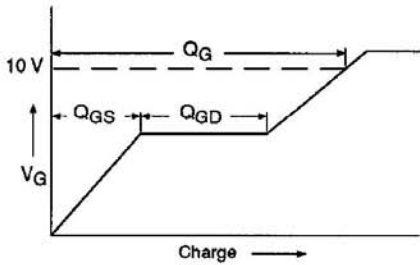

**Fig 13a.** Basic Gate Charge Waveform

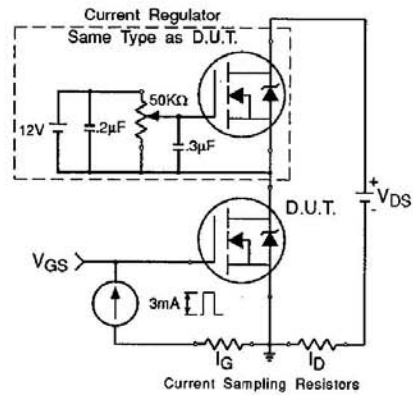

**Fig 13b.** Gate Charge Test Circuit

**Appendix A:** Figure 14, Peak Diode Recovery  $dv/dt$  Test Circuit – See page 1505

**Appendix B:** Package Outline Mechanical Drawing – See page 1509

**Appendix E:** Optional Leadforms – See page 1525

International  
**IR** Rectifier

www.irf.com

## TO-220AB Package Outline

Dimensions are shown in millimeters (inches)

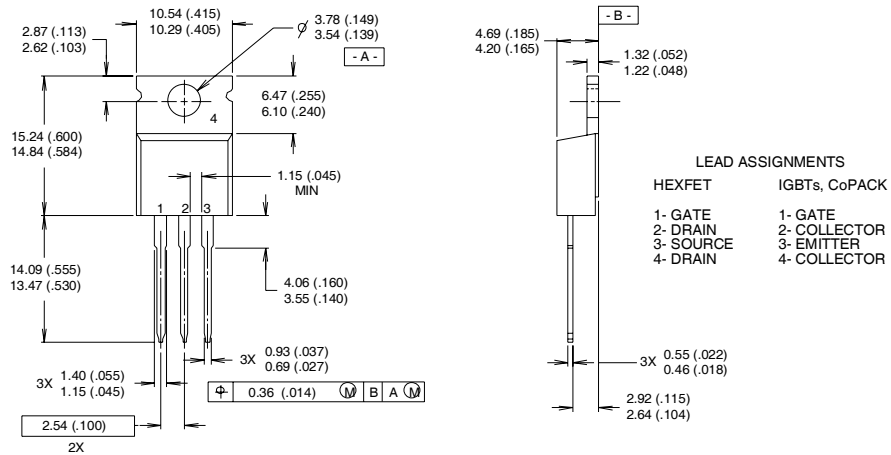

**NOTES:**

- 1 DIMENSIONING & TOLERANCING PER ANSI Y14.5M, 1982.
- 2 CONTROLLING DIMENSION : INCH

- 3 OUTLINE CONFORMS TO JEDEC OUTLINE TO-220AB.
- 4 HEATSINK & LEAD MEASUREMENTS DO NOT INCLUDE BURRS.

## TO-220AB Part Marking Information

EXAMPLE: THIS IS AN IRF1010  
 LOT CODE 1789  
 ASSEMBLED ON WW 19, 1997  
 IN THE ASSEMBLY LINE "C"  
**Note:** "P" in assembly line  
 position indicates "Lead-Free"

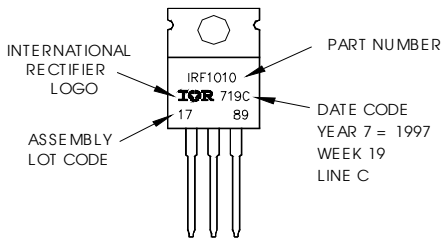

Data and specifications subject to change without notice.