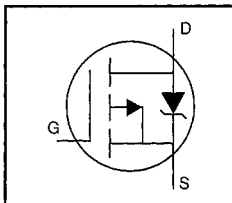


## HEXFET® Power MOSFET

- Surface Mount
- Available in Tape & Reel
- Dynamic dv/dt Rating
- Repetitive Avalanche Rated
- P-Channel
- Fast Switching
- Ease of Paralleling



$$V_{DSS} = -200V$$

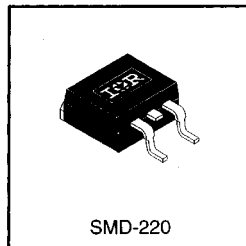
$$R_{DS(on)} = 0.80\Omega$$

$$I_D = -6.5A$$

### Description

Third Generation HEXFETs from International Rectifier provide the designer with the best combination of fast switching, ruggedized device design, low on-resistance and cost-effectiveness.

The SMD-220 is a surface mount power package capable of accommodating die sizes up to HEX-4. It provides the highest power capability and the lowest possible on-resistance in any existing surface mount package. The SMD-220 is suitable for high current applications because of its low internal connection resistance and can dissipate up to 2.0W in a typical surface mount application.



DATA SHEETS

### Absolute Maximum Ratings

	Parameter	Max.	Units
$I_D$ @ $T_C = 25^\circ C$	Continuous Drain Current, $V_{GS} @ -10 V$	-6.5	A
$I_D$ @ $T_C = 100^\circ C$	Continuous Drain Current, $V_{GS} @ -10 V$	-4.0	
$I_{DM}$	Pulsed Drain Current ①	-26	
$P_D$ @ $T_C = 25^\circ C$	Power Dissipation	74	W
$P_D$ @ $T_A = 25^\circ C$	Power Dissipation (PCB Mount)**	3.0	
	Linear Derating Factor	0.59	W/°C
	Linear Derating Factor (PCB Mount)**	0.025	
$V_{GS}$	Gate-to-Source Voltage	±20	V
$E_{AS}$	Single Pulse Avalanche Energy ②	500	mJ
$I_{AR}$	Avalanche Current ①	-6.4	A
$E_{AR}$	Repetitive Avalanche Energy ①	7.4	mJ
dv/dt	Peak Diode Recovery dv/dt ③	-5.0	V/ns
$T_J, T_{STG}$	Junction and Storage Temperature Range	-55 to +150	°C
	Soldering Temperature, for 10 seconds	300 (1.6mm from case)	


### Thermal Resistance

	Parameter	Min.	Typ.	Max.	Units
$R_{\theta JC}$	Junction-to-Case	—	—	1.7	°C/W
$R_{\theta JA}$	Junction-to-Ambient (PCB mount)**	—	—	40	
$R_{\theta JA}$	Junction-to-Ambient	—	—	62	


\*\* When mounted on 1" square PCB (FR-4 or G-10 Material).

For recommended footprint and soldering techniques refer to application note #AN-994.

## Electrical Characteristics @ $T_J = 25^\circ\text{C}$ (unless otherwise specified)

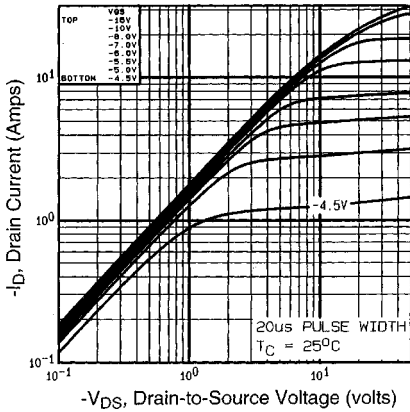
	Parameter	Min.	Typ.	Max.	Units	Test Conditions
$V_{(BR)DSS}$	Drain-to-Source Breakdown Voltage	-200	—	—	V	$V_{GS}=0V, I_D=-250\mu A$
$\Delta V_{(BR)DSS}/\Delta T_J$	Breakdown Voltage Temp. Coefficient	—	-0.24	—	V/°C	Reference to $25^\circ\text{C}$ , $I_D=-1mA$
$R_{DS(on)}$	Static Drain-to-Source On-Resistance	—	—	0.80	$\Omega$	$V_{GS}=10V, I_D=-3.9A$ ④
$V_{GS(th)}$	Gate Threshold Voltage	-2.0	—	-4.0	V	$V_{DS}=V_{GS}, I_D=-250\mu A$
$g_{fs}$	Forward Transconductance	2.8	—	—	S	$V_{DS}=-50V, I_D=-3.9A$ ④
$I_{DSS}$	Drain-to-Source Leakage Current	—	—	-100	$\mu A$	$V_{DS}=-200V, V_{GS}=0V$
		—	—	-500		$V_{DS}=-160V, V_{GS}=0V, T_J=125^\circ\text{C}$
$I_{GSS}$	Gate-to-Source Forward Leakage	—	—	-100	nA	$V_{GS}=-20V$
	Gate-to-Source Reverse Leakage	—	—	100		$V_{GS}=20V$
$Q_g$	Total Gate Charge	—	—	29	nC	$I_D=-6.5A$
$Q_{gs}$	Gate-to-Source Charge	—	—	5.4		$V_{DS}=-160V$
$Q_{gd}$	Gate-to-Drain ("Miller") Charge	—	—	15		$V_{GS}=-10V$ See Fig. 6 and 13 ④
$t_{d(on)}$	Turn-On Delay Time	—	12	—	ns	$V_{DD}=-100V$
$t_r$	Rise Time	—	27	—		$I_D=-6.5A$
$t_{d(off)}$	Turn-Off Delay Time	—	28	—		$R_G=12\Omega$
$t_f$	Fall Time	—	24	—		$R_D=15\Omega$ See Figure 10 ④
$L_D$	Internal Drain Inductance	—	4.5	—	nH	Between lead, 6 mm (0.25in.) from package and center of die contact 
$L_S$	Internal Source Inductance	—	7.5	—		
$C_{iss}$	Input Capacitance	—	700	—	pF	$V_{GS}=0V$
$C_{oss}$	Output Capacitance	—	200	—		$V_{DS}=-25V$
$C_{rss}$	Reverse Transfer Capacitance	—	40	—		$f=1.0MHz$ See Figure 5

## Source-Drain Ratings and Characteristics

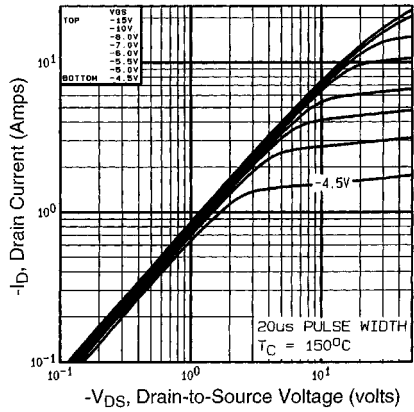
	Parameter	Min.	Typ.	Max.	Units	Test Conditions
$I_S$	Continuous Source Current (Body Diode)	—	—	-6.5	A	MOSFET symbol showing the integral reverse p-n junction diode. 
$I_{SM}$	Pulsed Source Current (Body Diode) ①	—	—	-26		
$V_{SD}$	Diode Forward Voltage	—	—	-6.5	V	$T_J=25^\circ\text{C}, I_S=-6.5A, V_{GS}=0V$ ④
$t_{rr}$	Reverse Recovery Time	—	200	300	ns	$T_J=25^\circ\text{C}, I_F=-6.5A$
$Q_{rr}$	Reverse Recovery Charge	—	1.9	2.9	$\mu C$	$di/dt=100A/\mu s$ ④
$t_{on}$	Forward Turn-On Time	Intrinsic turn-on time is negligible (turn-on is dominated by $L_S+L_D$ )				

### Notes:

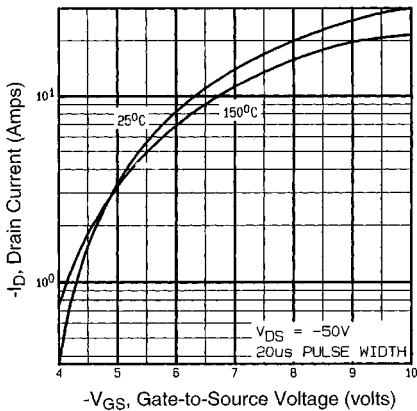
- ① Repetitive rating; pulse width limited by max. junction temperature (See Figure 11)
- ②  $V_{DD}=-50V$ , starting  $T_J=25^\circ\text{C}$ ,  $L=17mH$ ,  $R_G=25\Omega$ ,  $I_{AS}=-6.5A$  (See Figure 12)
- ③  $I_{SD}\leq 6.5A$ ,  $di/dt\leq 120A/\mu s$ ,  $V_{DD}\leq V_{(BR)DSS}$ ,  $T_J\leq 150^\circ\text{C}$
- ④ Pulse width  $\leq 300\mu s$ ; duty cycle  $\leq 2\%$ .



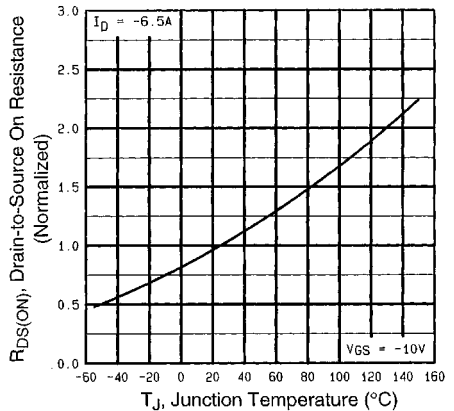
**Fig 1.** Typical Output Characteristics,  $T_C=25^\circ\text{C}$



**Fig 2.** Typical Output Characteristics,  $T_C=150^\circ\text{C}$

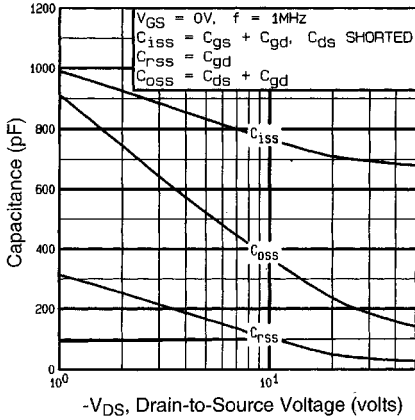


**Fig 3.** Typical Transfer Characteristics

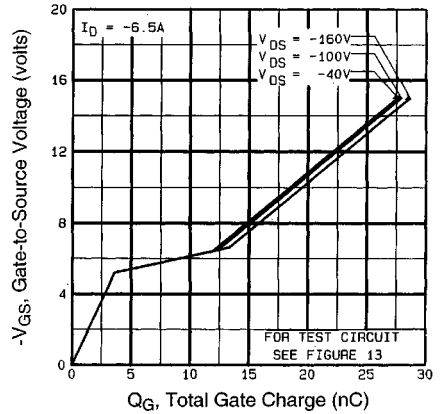


**Fig 4.** Normalized On-Resistance Vs. Temperature

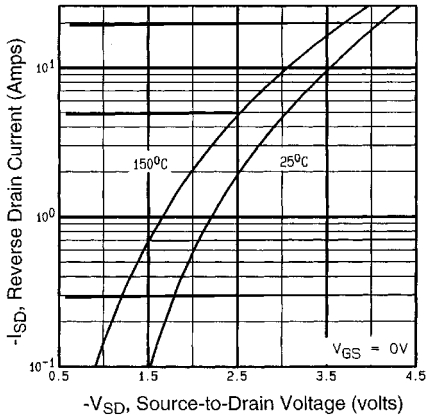
DATA SHEETS



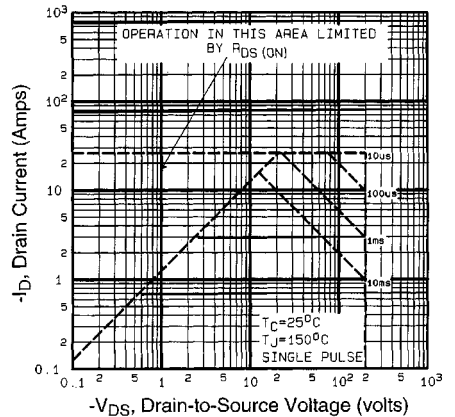
**Fig 5.** Typical Capacitance Vs. Drain-to-Source Voltage



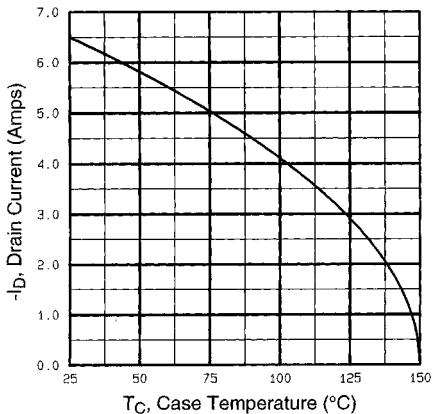
**Fig 6.** Typical Gate Charge Vs. Gate-to-Source Voltage



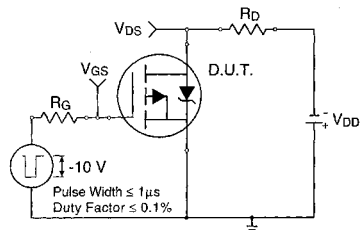
**Fig 7.** Typical Source-Drain Diode Forward Voltage



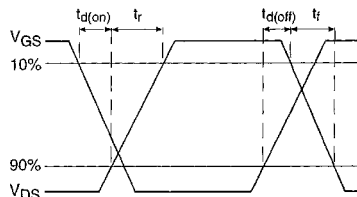
**Fig 8.** Maximum Safe Operating Area



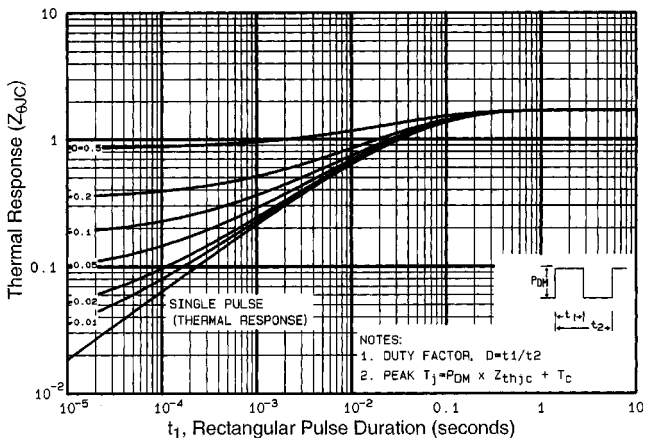
**Fig 9.** Maximum Drain Current Vs. Case Temperature



**Fig 10a.** Switching Time Test Circuit

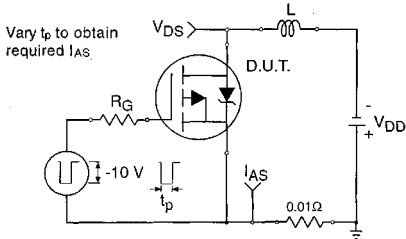


**Fig 10b.** Switching Time Waveforms

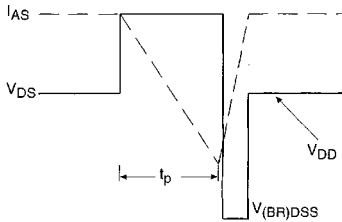


**Fig 11.** Maximum Effective Transient Thermal Impedance, Junction-to-Case

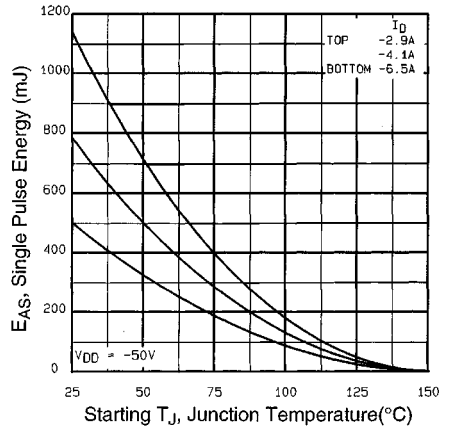
DATA SHEETS



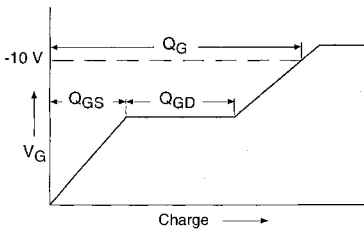
**Fig 12a.** Unclamped Inductive Test Circuit



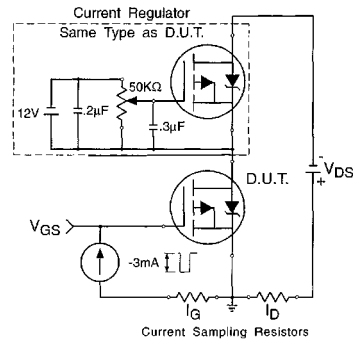
**Fig 12b.** Unclamped Inductive Waveforms



**Fig 12c.** Maximum Avalanche Energy Vs. Drain Current



**Fig 13a.** Basic Gate Charge Waveform



**Fig 13b.** Gate Charge Test Circuit

**Appendix A:** Figure 14, Peak Diode Recovery  $dv/dt$  Test Circuit – See page 1506

**Appendix B:** Package Outline Mechanical Drawing – See page 1507

**Appendix C:** Part Marking Information – See page 1515

**Appendix D:** Tape & Reel Information – See page 1519